

2SK2007

Silicon N Channel MOS FET

Application

High speed power switching

Features

- Low on-resistance
- High speed switching
- Low drive current
- No Secondary Breakdown
- Suitable for Switching regulator, DC – DC converter, Motor Control

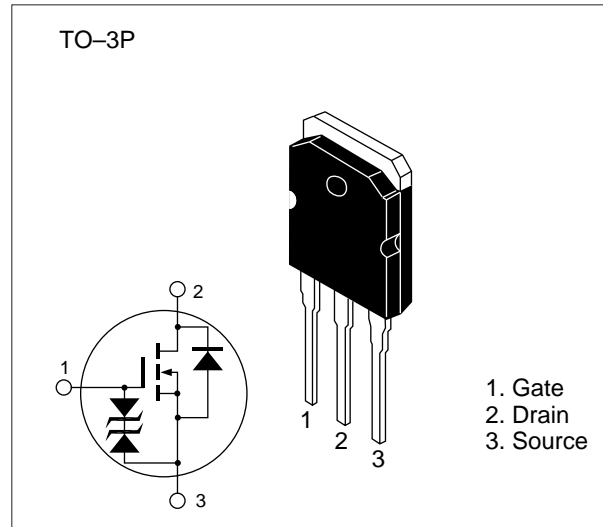

Table 1 Absolute Maximum Ratings ($T_a = 25^\circ\text{C}$)

Item	Symbol	Ratings	Unit
Drain to source voltage	V_{DSS}	250	V
Gate to source voltage	V_{GSS}	± 30	V
Drain current	I_D	20	A
Drain peak current	$I_{D(\text{pulse})}^*$	80	A
Body-drain diode reverse drain current	I_{DR}	20	A
Channel dissipation	P_{ch}^{**}	100	W
Channel temperature	T_{ch}	150	$^\circ\text{C}$
Storage temperature	T_{stg}	-55 to +150	$^\circ\text{C}$

* $PW \leq 10 \mu\text{s}$, duty cycle $\leq 1\%$

** Value at $T_c = 25^\circ\text{C}$

Table 2 Electrical Characteristics ($T_a = 25^\circ\text{C}$)

Item	Symbol	Min	Typ	Max	Unit	Test conditions
Drain to source breakdown voltage	$V_{(BR)DSS}$	250	—	—	V	$I_D = 10\text{ mA}, V_{GS} = 0$
Gate to source breakdown voltage	$V_{(BR)GSS}$	± 30	—	—	V	$I_G = \pm 100\text{ }\mu\text{A}, V_{DS} = 0$
Gate to source leak current	I_{GSS}	—	—	± 10	μA	$V_{GS} = \pm 25\text{ V}, V_{DS} = 0$
Zero gate voltage drain current	I_{DSS}	—	—	250	μA	$V_{DS} = 200\text{ V}, V_{GS} = 0$
Gate to source cutoff voltage	$V_{GS(off)}$	2.0	—	3.0	V	$I_D = 1\text{ mA}, V_{DS} = 10\text{ V}$
Static drain to source on state resistance	$R_{DS(on)}$	—	0.12	0.15	Ω	$I_D = 10\text{ A}$ $V_{GS} = 10\text{ V}^*$
Forward transfer admittance	$ y_{fs} $	9.0	14	—	S	$I_D = 10\text{ A}$ $V_{DS} = 10\text{ V}^*$
Input capacitance	C_{iss}	—	2340	—	pF	$V_{DS} = 10\text{ V}$
Output capacitance	C_{oss}	—	1000	—	pF	$V_{GS} = 0$
Reverse transfer capacitance	C_{rss}	—	160	—	pF	$f = 1\text{ MHz}$
Turn-on delay time	$t_{d(on)}$	—	30	—	ns	$I_D = 10\text{ A}$
Rise time	t_r	—	125	—	ns	$V_{GS} = 10\text{ V}$
Turn-off delay time	$t_{d(off)}$	—	190	—	ns	$R_L = 3\text{ }\Omega$
Fall time	t_f	—	100	—	ns	
Body-drain diode forward voltage	V_{DF}	—	1.2	—	V	$I_F = 20\text{ A}, V_{GS} = 0$
Body-drain diode reverse recovery time	t_{rr}	—	120	—	ns	$I_F = 20\text{ A}, V_{GS} = 0,$ $di_F / dt = 100\text{ A} / \mu\text{s}$

* Pulse Test

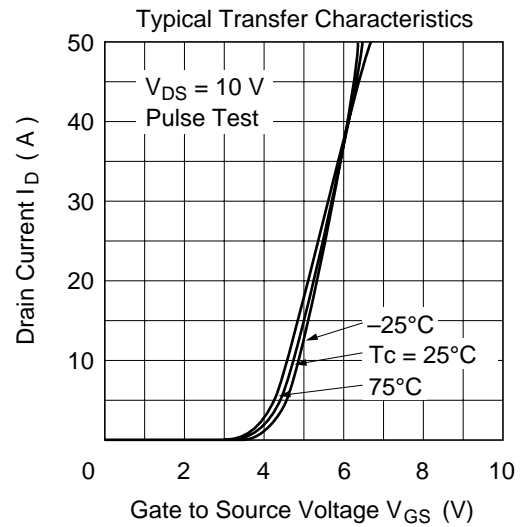
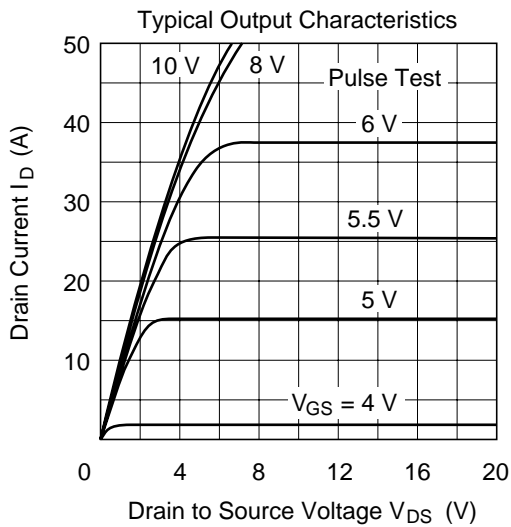
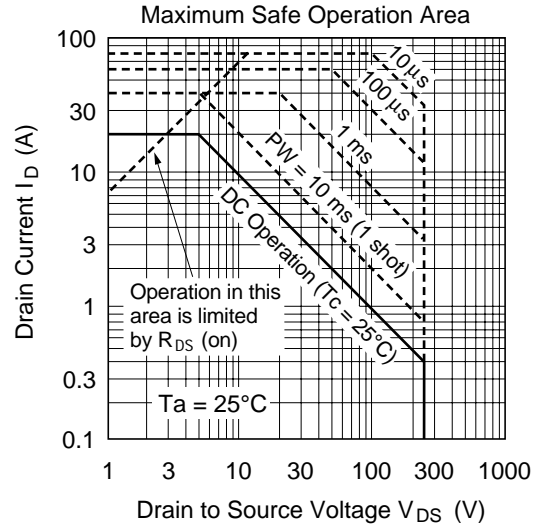
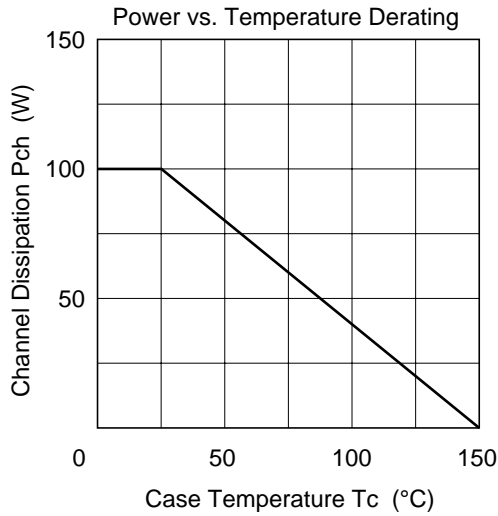

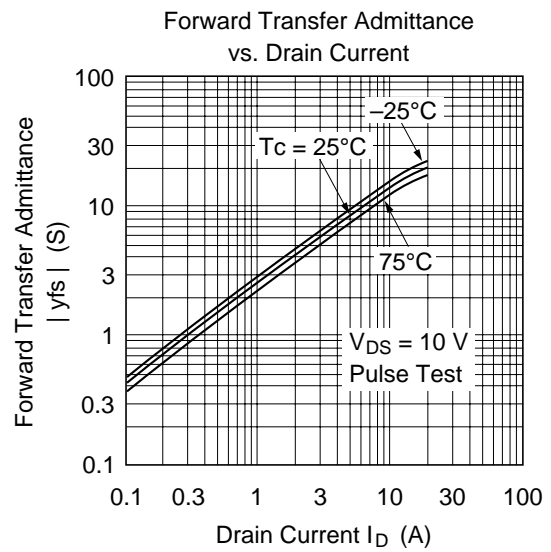
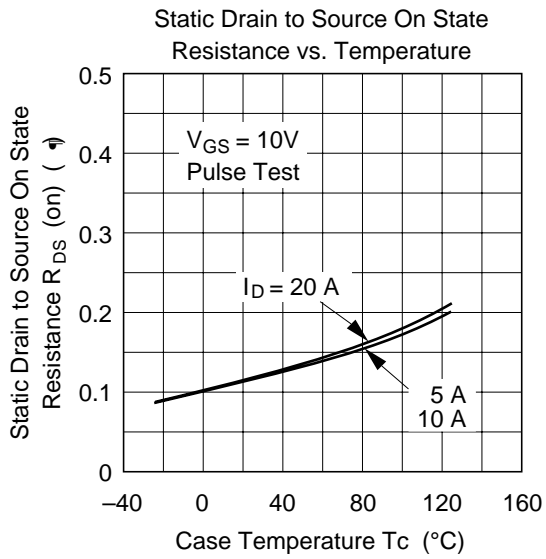
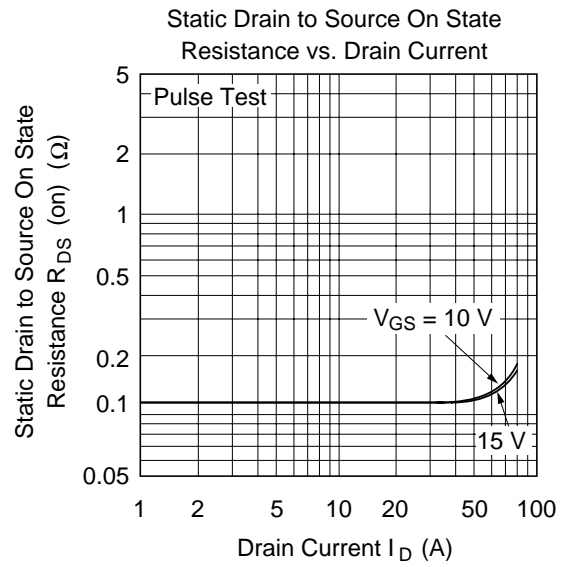
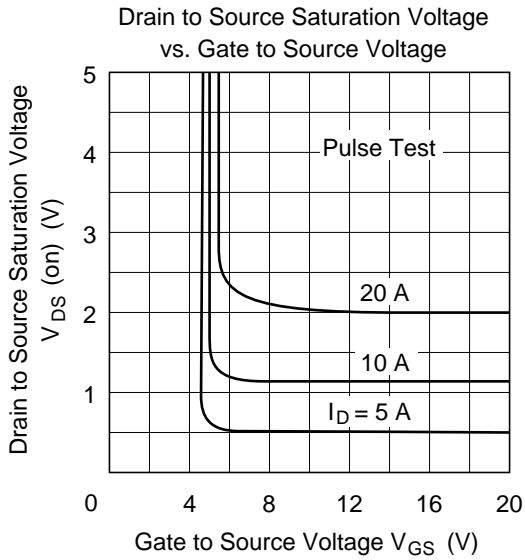

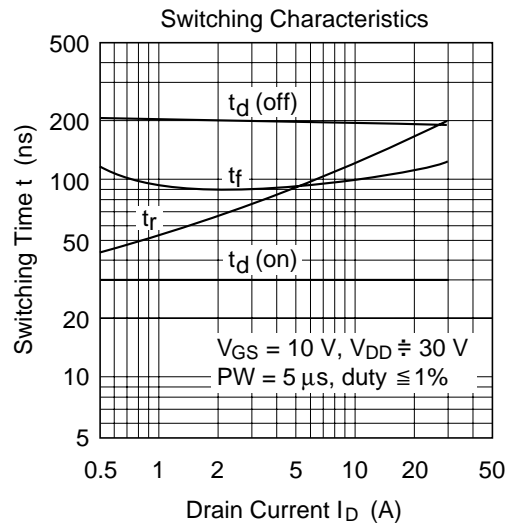
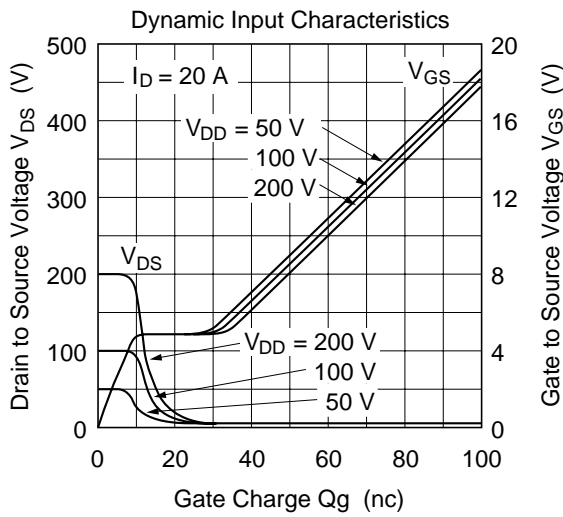
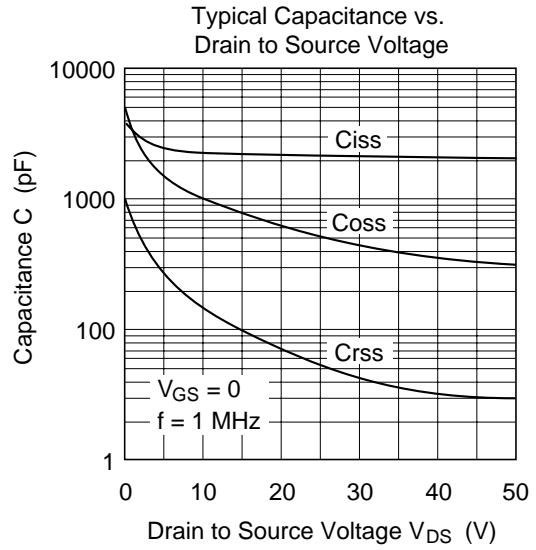
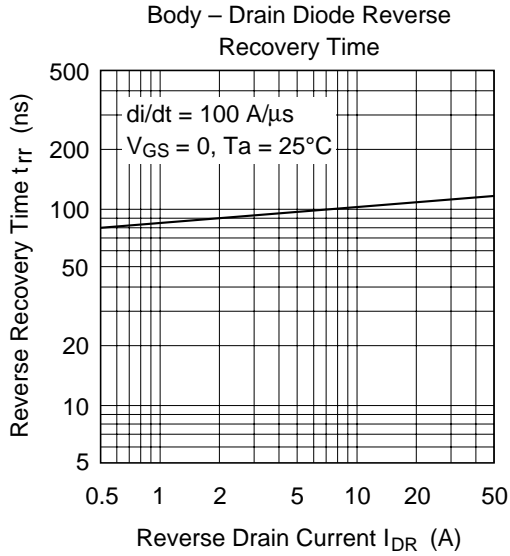

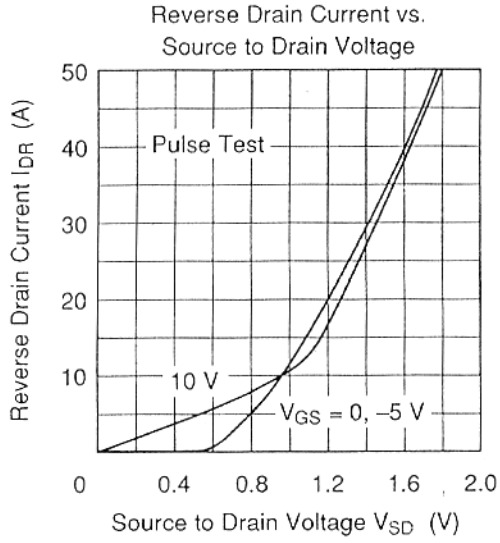

NORMALIZED TRANSIENT THERMAL IMPEDANCE VS. PULSE WIDTH

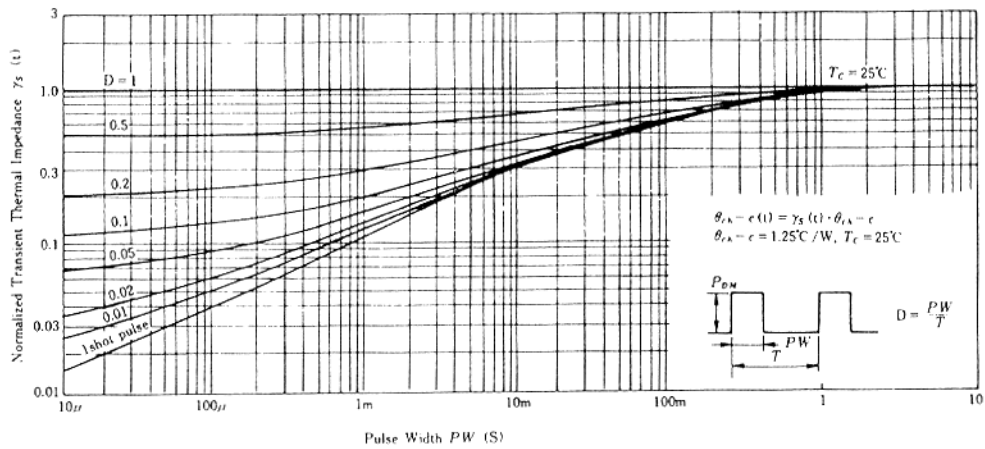

SWITCHING TIME TEST CIRCUIT

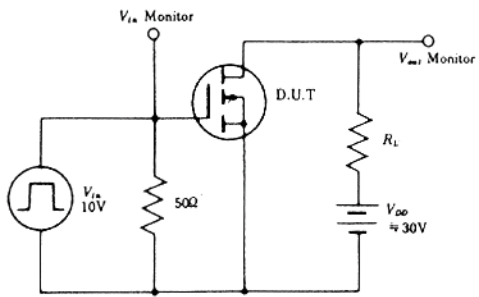

WAVEFORMS

